

# GPS 16

*GPS receiver/antenna*

quick  
start  
guide



© 2001 GARMIN Ltd. or its subsidiaries

GARMIN International, Inc.  
1200 East 151<sup>st</sup> Street, Olathe, Kansas 66062, U.S.A.  
Tel. 913/397.8200 or 800/800.1020  
Fax 913/397.8282

GARMIN (Europe) Ltd.  
Unit 5, The Quadrangle, Abbey Park Industrial Estate, Romsey, SO51 9AQ, U.K.  
Tel. 44/1794.519944  
Fax 44/1794.519222

GARMIN Corporation  
No. 68, Jangshu 2<sup>nd</sup> Rd., Shijr, Taipei County, Taiwan  
Tel. 886/02.2642.9199  
Fax 886/02.2642.9099

All rights reserved. Except as expressly provided herein, no part of this manual may be reproduced, copied, transmitted, disseminated, downloaded or stored in any storage medium, for any purpose without prior written consent of GARMIN. GARMIN hereby grants permission to download a single copy of this manual onto a hard drive or other electronic storage medium to be viewed for personal use, provided that such electronic or printed copy of this manual contains the complete text of this copyright notice and provided further that any unauthorized commercial distribution of this manual is strictly prohibited.

Information in this manual is subject to change without notice. GARMIN reserves the right to change or improve its products and to make changes in the content without obligation to notify any person or organization of such changes. Visit the GARMIN web site ([www.garmin.com](http://www.garmin.com)) for current updates and supplemental information concerning the use and operation of this and other GARMIN products.

GARMIN® and AutoLocate® are registered trademarks of GARMIN Ltd. or its subsidiaries and may not be used without the express permission of GARMIN.

### Limited Warranty

GARMIN warrants this product to be free from defects in materials and workmanship for one year from the date of purchase. GARMIN will, at its sole option, repair or replace any components that fail in normal use. Such repairs or replacement will be made at no charge to the customer for parts or labor. The customer is, however, responsible for any transportation costs. This warranty does not cover failures due to abuse, misuse, accident or unauthorized alteration or repairs.

THE WARRANTIES AND REMEDIES CONTAINED HEREIN ARE EXCLUSIVE AND IN LIEU OF ALL OTHER WARRANTIES EXPRESS OR IMPLIED OR STATUTORY, INCLUDING ANY LIABILITY ARISING UNDER ANY WARRANTY OF MERCHANTABILITY OR FITNESS FOR A PARTICULAR PURPOSE, STATUTORY OR OTHERWISE. THIS WARRANTY GIVES YOU SPECIFIC LEGAL RIGHTS, WHICH MAY VARY FROM STATE TO STATE.

IN NO EVENT SHALL GARMIN BE LIABLE FOR ANY INCIDENTAL, SPECIAL, INDIRECT OR CONSEQUENTIAL DAMAGES, WHETHER RESULTING FROM THE USE, MISUSE, OR INABILITY TO USE THIS PRODUCT OR FROM DEFECTS IN THE PRODUCT. SOME STATES DO NOT ALLOW THE EXCLUSION OF INCIDENTAL OR CONSEQUENTIAL DAMAGES, SO THE ABOVE LIMITATIONS MAY NOT APPLY TO YOU.

To obtain warranty service, contact your GARMIN dealer or call the GARMIN Customer Service department (913-397-8200) for a returned merchandise tracking number. The unit should be securely packaged with the tracking number clearly marked on the outside of the package and sent freight prepaid and insured to a GARMIN warranty service station. A copy of the original sales receipt is required as the proof of purchase for warranty repairs. GARMIN retains the exclusive right to repair or replace the unit or software or offer a full refund of the purchase price at its sole discretion. SUCH REMEDY SHALL BE YOUR SOLE AND EXCLUSIVE REMEDY FOR ANY BREACH OF WARRANTY.

## Cautions / FCC Compliance



*The GARMIN GPS 16 does not contain any user-serviceable parts. Repairs should only be made by an authorized GARMIN service center. Unauthorized repairs or modifications could result in permanent damage to the equipment, and void your warranty and your authority to operate this device under Part 15 regulations.*



*If this equipment does cause harmful interference to radio or television reception, which can be determined by turning the equipment off and on, the user is encouraged to try to correct the interference by one or more of the following measures:*

- Reorient or relocate the receiving antenna.*
- Increase the separation between the equipment and receiver.*
- Connect the equipment into an outlet on a circuit different from that to which the receiver is connected.*
- Consult the dealer or an experienced radio/TV technician for help.*

The GPS system is operated by the government of the United States which is solely responsible for their accuracy and maintenance. The Global Positioning System and the Differential Global Positioning System are under development and are subject to changes which could affect accuracy and performance of all GPS equipment. Although a GPS system is a precision electronic NAVigation AID (NAVAID), any NAVAID can be misused or misinterpreted, and therefore become unsafe. Use the GPS system at your own risk. To reduce this risk, carefully review and understand all aspects of this Quick Start Guide and carefully compare indications from your output to all available navigation sources including the information from other NAVAIDs, visual sightings, charts, etc. For safety, always resolve any discrepancies before continuing navigation.

### **FCC Compliance**

The GPS 16 complies with Part 15 of the FCC interference limits for Class B digital devices FOR HOME OR OFFICE USE. These limits are designed to provide reasonable protection against harmful interference in a residential installation, and are more stringent than “outdoor” requirements.

Operation of this device is subject to the following conditions: (1) This device may not cause harmful interference, and (2) this device must accept any interference received, including interference that may cause undesired operation.

This equipment generates, uses and can radiate radio frequency energy and, if not installed and used in accordance with the instructions, may cause harmful interference to radio communications. However, there is no guarantee that interference will not occur in a particular installation.

## Table of Contents

### Introduction

Limited Warranty.....	1
Cautions .....	2
Table of Contents .....	3

### Overview

Capabilities & Package Contents.....	4
Specifications.....	5

### Installation

Mounting the GPS 16.....	6-7
Wiring the GPS 16.....	8-10

### Operation

Using the GPS 16 .....	11-12
------------------------	-------

## Capabilities & Package Contents

### Package Contents

Your GARMIN GPS 16 package includes:

- GPS 16 unit with 17 ft. (5 m) Power/Data Cable

**If any parts are missing or damaged, please contact your GARMIN dealer immediately.**

*Technical Specifications for the GPS 16 may be downloaded from the GARMIN web site at [www.garmin.com/support](http://www.garmin.com/support)*

### Capabilities

The GPS 16 offers a host of powerful capabilities for enhanced performance and accuracy:

- **Performance**— WAAS enabled, 12-channel GPS receiver tracks and uses up to 12 satellites for fast, accurate positioning.
- **Ease of Use**— Once installed, unit will automatically transmit navigation data.
- **Convenience**— May be remotely mounted in an out-of-the-way location. Receiver status information can be displayed directly on a chartplotter or PC.
- **GPS Accuracy**

Position: < 15 meters, 95% (typical)\*

Velocity: .1 knot RMS steady state

- **DGPS (USCG) Accuracy**

Position: 3-5 meters, 95% (typical)

Velocity: .1 knot RMS steady state

- **DGPS (WAAS) Accuracy**

Position: < 3 meters, 95% (typical)

Velocity: .1 knot RMS steady state

- **Acquisition Times\*\***

Reacquisition: Less than 2 seconds

Warm: Approximately 15 seconds

Cold: Approximately 45 seconds

AutoLocate: Approximately 5 minutes

Skysearch: Approximately 5 minutes

\* Subject to accuracy degradation to 100m 2DRMS under the U.S. Department of Defense imposed Selective Availability Program.

\*\* Warm = all data known; Cold = position, time and almanac known; AutoLocate = almanac known, position and time unknown; Skysearch = no data known.

## Physical

<b>Size:</b>	3.39"D x 1.65"H (86 mm x 42 mm)
<b>Weight:</b>	11.7 oz. (332 g) with 5 meter cable
<b>Operating Range:</b>	-22°F to +176°F (-30°C to +80°C)
<b>Waterproof:</b>	-1 meter submersion for 30 minutes IPX7 rating for IEC529
<b>Cable:</b>	17 ft. (5 m) Foil-shielded 8 conductor 28 AWG; RJ-45 Connector
<b>Dynamics:</b>	999 knots, 6g's

## Power

<b>Voltage:</b>	
<b>GPS 16 LVS:</b>	3.3 to 6 Vdc regulated to <100 mV ripple
<b>GPS 16 HVS:</b>	6 to 40 Vdc unregulated
<b>Current Drain:</b>	
<b>GPS 16 LVS:</b>	80 mA (typical)
<b>GPS 16 HVS:</b>	100 mA @ 6 Vdc; 65 mA @ 12 Vdc; 28 mA @ 40 Vdc
<b>Sensitivity:</b>	-165 dBW minimum

## Interfaces

<b>Serial Interface:</b>	True RS-232 output (Port 2 input only), asynchronous serial input compatible with RS-232 or TTL voltage levels, RS-232 polarity
<b>Baud Rates:</b>	300 to 19200
<b>Serial Format:</b>	
<b>Port 1:</b>	Selectable between NMEA and GARMIN. NMEA 0183 v2.00/3.00 (ASCII) transmitted every two seconds, GPALM, GPGGA, GPGLL, GPGSA, GPGSV, GPRMC, GPVTG, PGRMB, PGRME, PGRMF, PGRMM, PGRMT and PGRMV output.
<b>Port 2:</b>	RTCM Input Only. RTCM SC-104 differential input message types 1, 2, 3, 7 and 9
<b>PPS Output:</b>	1 Hz pulse, programmable width, 1 microsecond accuracy

## GPS 16 Specifications



Complete information concerning NMEA & RTCM formats and sentences is available for purchase at:

National Marine Electronics  
Association (NMEA)  
Seven Riggs Avenue  
Severna Park, MD 21146  
USA  
410/975.9425  
410/975.9450 FAX.  
[www.nmea.org](http://www.nmea.org)

Radio Technical Commission For  
Maritime Services (RTCM)  
1800 Diagonal Road, Suite 600  
Alexandria, VA 22314-2480,  
USA  
703/684.4481 (Info Only)  
703/836.4229 FAX  
[www.rtcmm.org](http://www.rtcmm.org)

## Mounting the GPS 16



*Note: As a general rule, mount the receiver at least three feet from all other antennas and electrical system components (alternator/ignition system).*

### **Mounting the Receiver**

*Please read through these instructions thoroughly before attempting installation. Make sure you completely understand these instructions before you begin. When in doubt, seek professional assistance.*

The following additional items are needed or optional to complete the installation of your GPS 16:

- **Receiver mount**— Since mounting locations and methods vary, you may need to obtain a mount to install the GPS 16. The receiver base uses either our Magnetic Mount or may be flush mounted.
- **On/Off switch (optional)**— Power to the receiver may be controlled by an on/off switch, such as an accessory switch on the control console. Check with an electric supply retailer for this item.

It is recommended that the system be temporarily hooked up with the wiring and the unit placed at the desired installation location. Then, check operation with potential interfering equipment turned on and off. (For example, other electronic equipment, fan motors, engine ignition, alternators, generators, radars and VHF radio transmissions can be sources of interference.)

Position the receiver so that the clearest possible view of the sky and horizon in all directions is obtained. Avoid mounting the receiver next to large areas of conductive material (metal, aluminum, etc.) as this may cause poor signal reception. The GPS 16 is supplied with a 17 foot (5 meter) power/data cable. When routing the wiring to the GPS 16, avoid routing the cable near an alternator or ignition system components or parallel to other power lines.



Three common sources of interference for GPS units are:

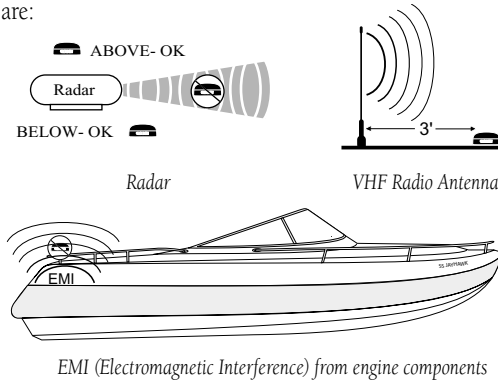

EMI (Electromagnetic Interference) from engine components

If a problem is found, try altering the location of the unit or wiring. Often moving the receiver a few feet away from the source of interference will solve the problem. When a suitable configuration is found, a permanent installation should be made. Select the mounting location according to your preferences. Keep in mind that from this mounting location cables will be routed to the NMEA 0183 listening device. Since mounting needs will vary, here are a couple basic methods:

### Mounting the GPS 16 with magnetic mount:

1. Align the magnetic mount, with the protective coating facing away from the unit base, with the 3 screw holes on the bottom of the receiver.
2. Insert and tighten the 3 screws.
3. Place the receiver on a clean, metallic surface and route cable accordingly.

### Flush mounting the GPS 16:

1. With the receiver upside down, using a piece of paper, punch holes at the 3 screw locations to create a template.
2. Use the template to mark and drill holes large enough for the screw to pass through at the marked location.
3. Align the receiver over the 3 holes and fasten the screws. The M4 thread inserts for the GPS 16 are 8.10mm deep. Do not use screws that will thread into the receiver any deeper, as this may damage the receiver.

## Mounting the GPS 16



When routing the power/data cable, try to avoid:

- Sharp edges which may cut the cable.
- Routing the cable parallel to other power lines.
- Excessively twisting, straining or bending the cable.

## Mounting the GPS 16

### **Wiring the GPS 16**

The final step in installing the GPS 16 is to connect the receiver's Port 1 DATA IN, DATA OUT, REMOTE ON/OFF and GROUND (Return) lines to your NMEA 0183 device or PC. Port 2 is used for RTCM input only. The GPS 16 may be plugged directly into a RJ-45 receptacle, which accepts NMEA 0183 data. It is recommended that a 1-amp, slow blow fuse be installed on the power (+) line of the receiving RJ-45 receptacle or equivalent device. Color coding of the wires is the same on all GPS 16 models (see wiring diagrams on following pages). If necessary, the wire coloring on the GPS 16 may be seen through the clear RJ-45 connector.

For reliable communication, it is essential that the GPS 16 and the receiving device share the same ground. This ground connection acts as the (signal) return line. It is recommended to wire the unit to its own circuit to avoid interference from other electronics.

### **Wire Coloring:**

1. RED- Power (+)
2. BLACK- Ground (Power (-) and Data Signal Return)
3. YELLOW- Remote power On/Off (Pull low for ON)
4. BLUE- Port 1 NMEA 0183 or GRMN Data Input
5. WHITE- Port 1 NMEA 0183 or GRMN Data Output
6. GRAY- Pulse Per Second Output (See Tech Specifications)
7. GREEN- Port 2 RTCM SC-104 Differential Data Input
8. VIOLET- Port 2 Data Output (Reserved for Future Use)

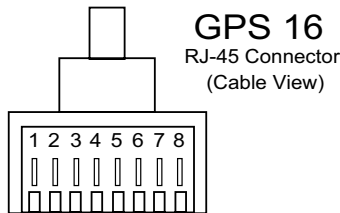

## Basic Wiring for the GPS 16 to a NMEA 0183 Device or PC Connector:

1. You may reference the following diagrams for the wiring: Connect the WHITE (Port 1 Data Out) wire from the GPS 16's power/data cable to the DATA INPUT line of the NMEA 0183 device or to pin 2 on a DB9 (pin 3 on DB25). You may typically output data to no more than three NMEA devices.
2. Connect the BLUE (Port 1 Data In) wire to the DATA OUTPUT line of the NMEA 0183 device or pin 3 on the DB9 (pin 2 on DB25).
3. Connect the BLACK (-) wire to the GROUND wire of the NMEA device or pin 5 on the DB9 (pin 7 on DB25). If connecting to a PC, you must also run a separate BLACK (-) wire to a power ground. If the BLACK wire is connected to the same ground terminal as the NMEA 0183 device, no additional connection is required, unless a separate data return line is required by the NMEA device).
4. Connect the RED (+) wire from the power/data cable to a DC power source.
5. If a remote power switch is being installed, reference the following page for wiring a switch. This will allow the GPS 16 to remain connected to a power source, but manually powered on (pull down to less than 0.5 volts) and off (open). Otherwise, if the receiver is being wired to a circuit which is already switched, (with the NMEA 0183 device for example) connect the YELLOW wire to the same place as the BLACK wire. When the BLACK and YELLOW wires are combined, the GPS 16 will turn on when power is applied to the RED (+) and BLACK (-) wires.

## Wiring the GPS 16



If the GPS 16 is being connected to a PC, a DB9 or DB25 serial connector (normally female) will be needed. Check with a PC or electronics supplier for this item.

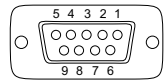

DB9 Female Serial Connector

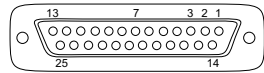

DB25 Female Serial Connector



Some non-GARMIN devices may have a separate data line labeled "RETURN", "DATA GROUND" or "DATA -". If one of these lines exist, connect the BLACK wire from the power/data cable to it.

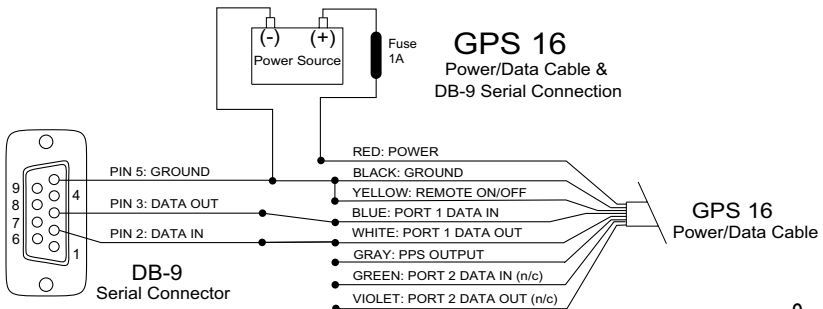

## Wiring the GPS 16

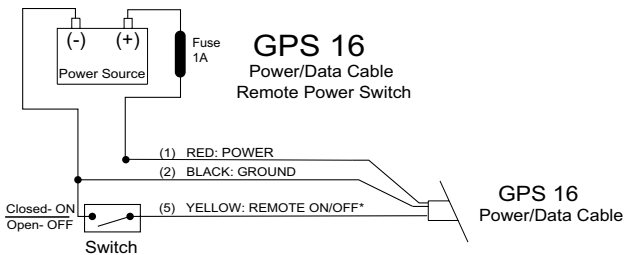
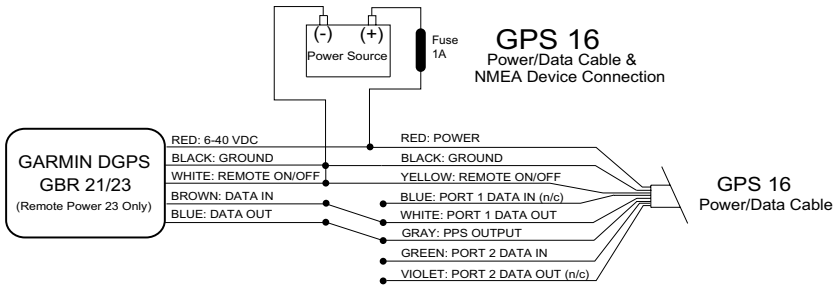
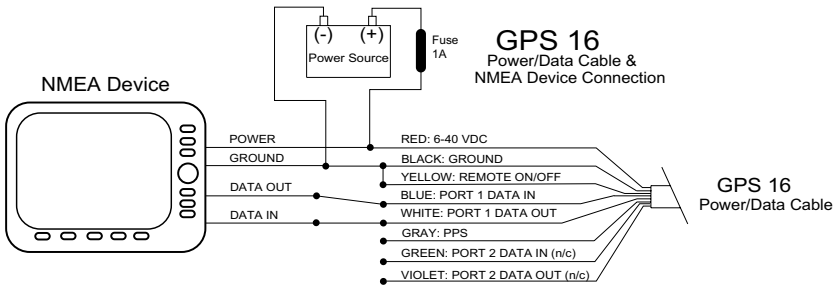

**First Time Fix**

The first time you power up your new GPS 16, the receiver must be given an opportunity to collect satellite data and establish its present position. To ensure proper initialization, the GPS 16 is shipped from the factory in AutoLocate mode, which will allow the receiver to “find itself” anywhere in the world.

Once the GPS 16 is installed and powered on, it will begin to search for satellites. The GPS 16 will output navigation data once it has calculated an initial position fix. By default, the following data will be output in NMEA 0183, Version 2.0 format:

- Latitude/Longitude/Altitude/Datum (GPGGA, GPRMC, GPGLL, PGRMM)
- Velocity (GPRMC)
- Date/Time (GPRMC)
- Error Estimates (PGRME)
- Satellite and Receiver Status (GPGSA, GPGSV, PGRMB, PGRMT)

**WAAS Capability**

The GPS 16 is capable of receiving WAAS (Wide Area Augmentation System) satellite signals. WAAS is an FAA (Federal Aviation Administration) funded project to improve the overall accuracy and integrity of the GPS signal for aviation use, but land/sea based users may also benefit from this system. At this time, the system is still in the development stage and is not fully operational. There are currently two WAAS satellites that can be received in the U.S.A., one over the Atlantic Ocean and one over the Pacific Ocean, in a geo-stationary orbit over the equator. Effective use of the WAAS satellite signal may be limited by your geographic location in relation to those satellites, now in developmental service. WAAS satellite signal reception requires an absolute clear view of the sky and works best when there are no nearby obstructions such as buildings, mountains, etc. WAAS satellites will be numbered 33 or higher when viewing the sky view on your NMEA device. First-time use of the WAAS feature may take up to 15-20 minutes to obtain differential

### Using the GPS 16



*The following NMEA transmitted sentences are enabled at the factory: GPGGA, GPGSA, GPGSV, GPRMC, PGRMB, PGRME, PGRMM, PGRMT and PSLIB*

positioning, then 1-2 minutes afterwards. When WAAS differential correction has been received for enough satellites, the NMEA 0183 data will indicate the availability of a differential fix in the GPGGA sentence. To learn more about the WAAS system, its satellite positions and current state of development, visit the FAA web site (<http://gps.faa.gov>).

### **Interfaces**

The GPS 16 serial Port 1 interface protocol design is based on the National Marine Electronics Association's (NMEA) 0183 ASCII interface specification, which is fully defined in "NMEA 0183, Version 2.0" and the Radio Technical Commission for Maritime Services "RTCM Recommended Standards For Differential Navstar GPS Service, Version 2.1, RTCM Special Committee No. 104". Contact information to obtain copies of the NMEA and RTCM specifications may be found on page 5. The GPS 16 may also be configured to output NMEA 0183, Version 3.0 data. See the technical specifications for more information.

Port 2 is designated for RTCM data input only. Output on Port 2 is reserved for future use.

The GPS 16 interface protocol also transmits additional information using the convention of GARMIN proprietary sentences (\$PGRMx). Complete information on GPS 16 capabilities, data transfer, NMEA 0183 sentence formats and descriptions can be found in the "GPS 16 Technical Specifications" (190-00228-20). You may order a copy of these specifications from GARMIN or your GARMIN dealer, or you may also download a copy from the manuals section of the GARMIN web site at [www.garmin.com/support/userManual.html](http://www.garmin.com/support/userManual.html).

The GPS 16 Port 1 is capable of transmitting the following NMEA 0183 data sentences:

GPALM, GPGGA, GPGLL, GPGSA, GPGSV, GPRMC, GPVTG, PGRME, PGRMF, PGRMM, PGRMT, PGRMV and PGRMB

The GPS 16 Port 1 is capable of receiving the following NMEA data sentences:

GPALM, PGRMI, PGRMC, PGRMC1, PGRMO and PSLIB.



**For the latest free software updates throughout the life of your  
GARMIN products, visit the GARMIN web site at [www.garmin.com](http://www.garmin.com)**



© 2001 GARMIN Ltd. or its subsidiaries

GARMIN International, Inc.  
1200 East 151st Street, Olathe, Kansas 66062, U.S.A.

GARMIN (Europe) Ltd.  
Unit 5, The Quadrangle, Abbey Park Industrial Estate, Romsey, SO51 9AQ, U.K.

GARMIN Corporation  
No. 68, Jangshu 2nd Road, Shijr, Taipei County, Taiwan

[www.garmin.com](http://www.garmin.com)

Part Number 190-00228-11 Rev. B