



Interrupts and System Calls

Don Porter



Logical Diagram

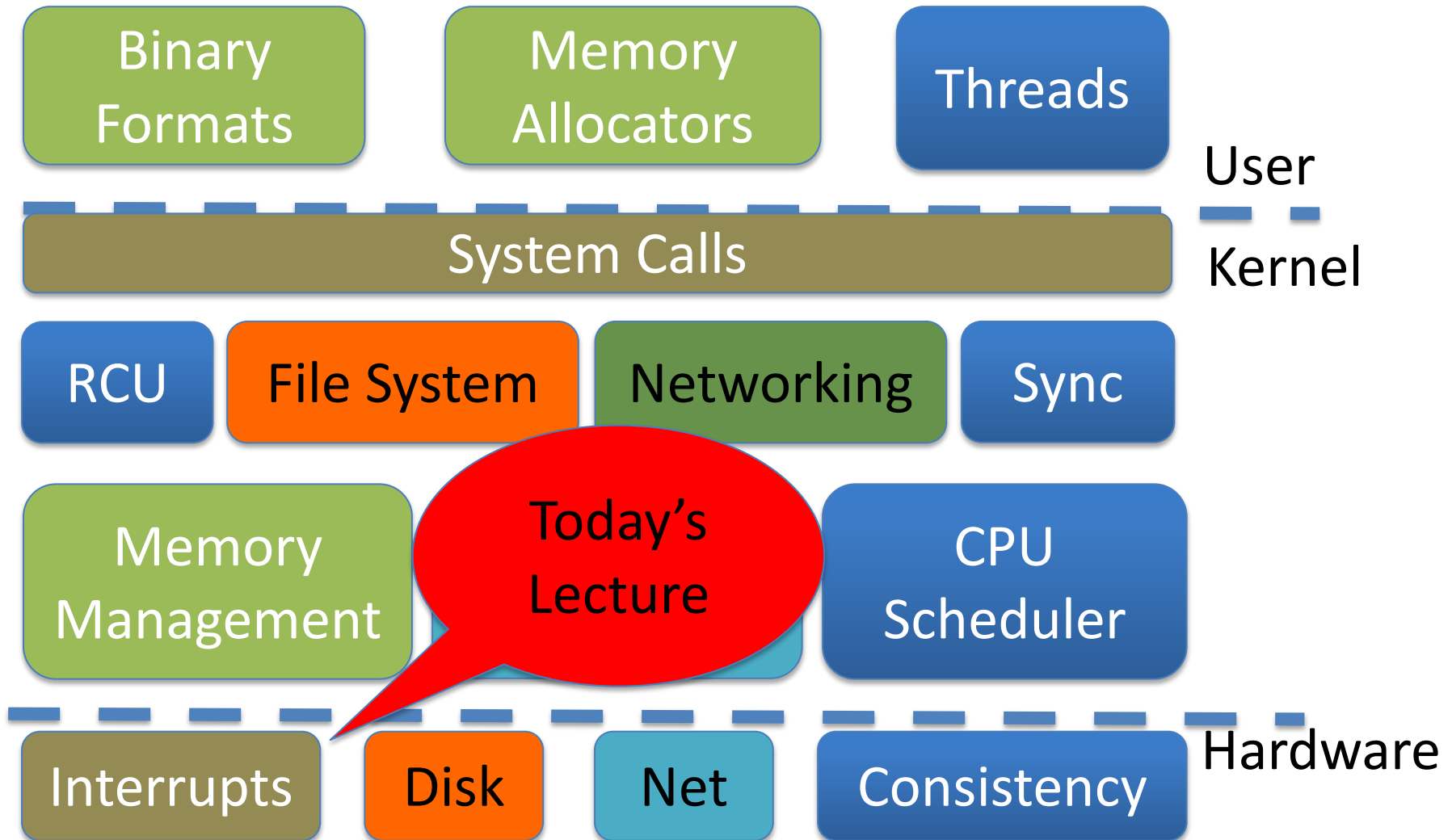



Background: Control Flow

pc

```
// x = 2,
// y = true
if (y) {
    2 /= x;
    printf(x);
} //...

void printf(va_args)
{
    //...
}
```

Regular control flow: branches and calls
(logically follows source code)



Background: Control Flow

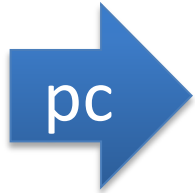

```
// x = 0  
// y =  
if (y)  
    2 /= x;  
    printf(x);  
} //...
```

Divide by zero!
Program can't make
progress!

```
void  
handle_divzero() {  
    x = 2;  
}
```

Irregular control flow: exceptions, system calls, etc.



Lecture goal

- Understand the hardware tools available for **irregular control flow**.
 - I.e., things other than a branch in a running program
- Building blocks for context switching, device management, etc.



Two types of interrupts

- Synchronous: will happen every time an instruction executes (with a given program state)
 - Divide by zero
 - System call
 - Bad pointer dereference
- Asynchronous: caused by an external event
 - Usually device I/O
 - Timer ticks (well, clocks can be considered a device)



Intel nomenclature

- Interrupt – only refers to asynchronous interrupts
- Exception – synchronous control transfer

- Note: from the programmer's perspective, these are handled with the same abstractions



Lecture outline

- Overview
- How interrupts work in hardware
- How interrupt handlers work in software
- How system calls work
- New system call hardware on x86



Interrupt overview

- Each interrupt or exception includes a number indicating its type
- E.g., 14 is a page fault, 3 is a debug breakpoint
- This number is the index into an interrupt table



x86 interrupt table

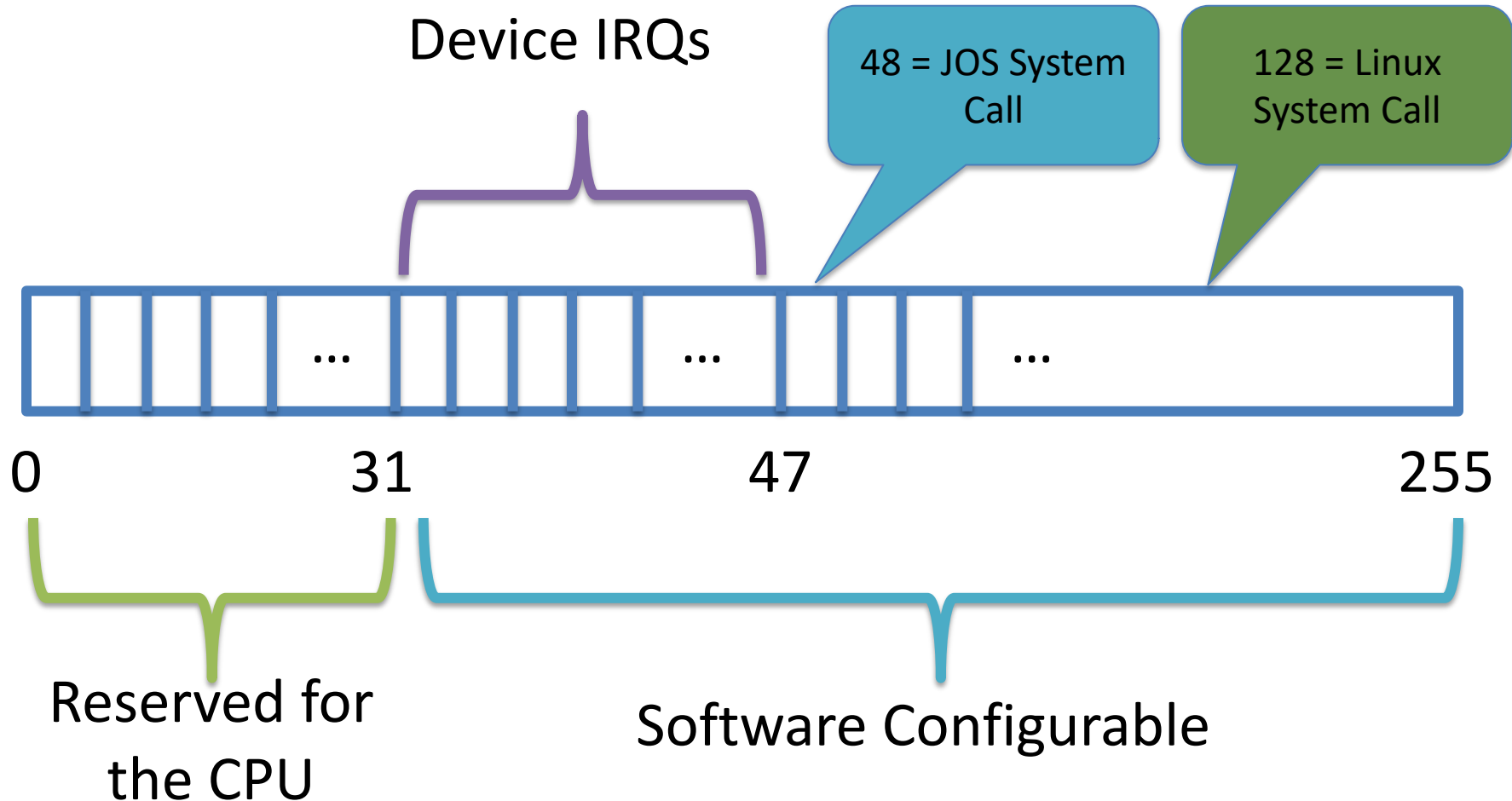



x86 interrupt overview

- Each type of interrupt is assigned an index from 0—255.
- 0—31 are for processor interrupts; generally fixed by Intel
 - E.g., 14 is always for page faults
- 32—255 are software configured
 - 32—47 are for device interrupts (IRQs) in JOS
 - Most device's IRQ line can be configured
 - Look up APICs for more info (Ch 4 of Bovet and Cesati)
 - 0x80 issues system call in Linux (more on this later)



Software interrupts

- The `int <num>` instruction allows software to raise an interrupt
 - 0x80 is just a Linux convention. JOS uses 0x30.
- There are a lot of spare indices
 - You could have multiple system call tables for different purposes or types of processes!
 - Windows does: one for the kernel and one for win32k



Software interrupts, cont

- OS sets ring level required to raise an interrupt
 - Generally, user programs can't issue an `int 14` (page fault) manually
 - An unauthorized `int` instruction causes a general protection fault
 - Interrupt 13



What happens (generally):

- Control jumps to the kernel
 - At a prescribed address (the interrupt handler)
- The register state of the program is dumped on the kernel's stack
 - Sometimes, extra info is loaded into CPU registers
 - E.g., page faults store the address that caused the fault in the `cr2` register
- Kernel code runs and handles the interrupt
- When handler completes, resume program (see `iret` instr.)



How it works (HW)

- How does HW know what to execute?
- Where does the HW dump the registers; what does it use as the interrupt handler's stack?



How is this configured?

- Kernel creates an array of Interrupt descriptors in memory, called Interrupt Descriptor Table, or IDT
 - Can be anywhere in memory
 - Pointed to by special register (`idt_r`)
 - c.f., segment registers and `gdtr` and `ldtr`
- Entry 0 configures interrupt 0, and so on



x86 interrupt table

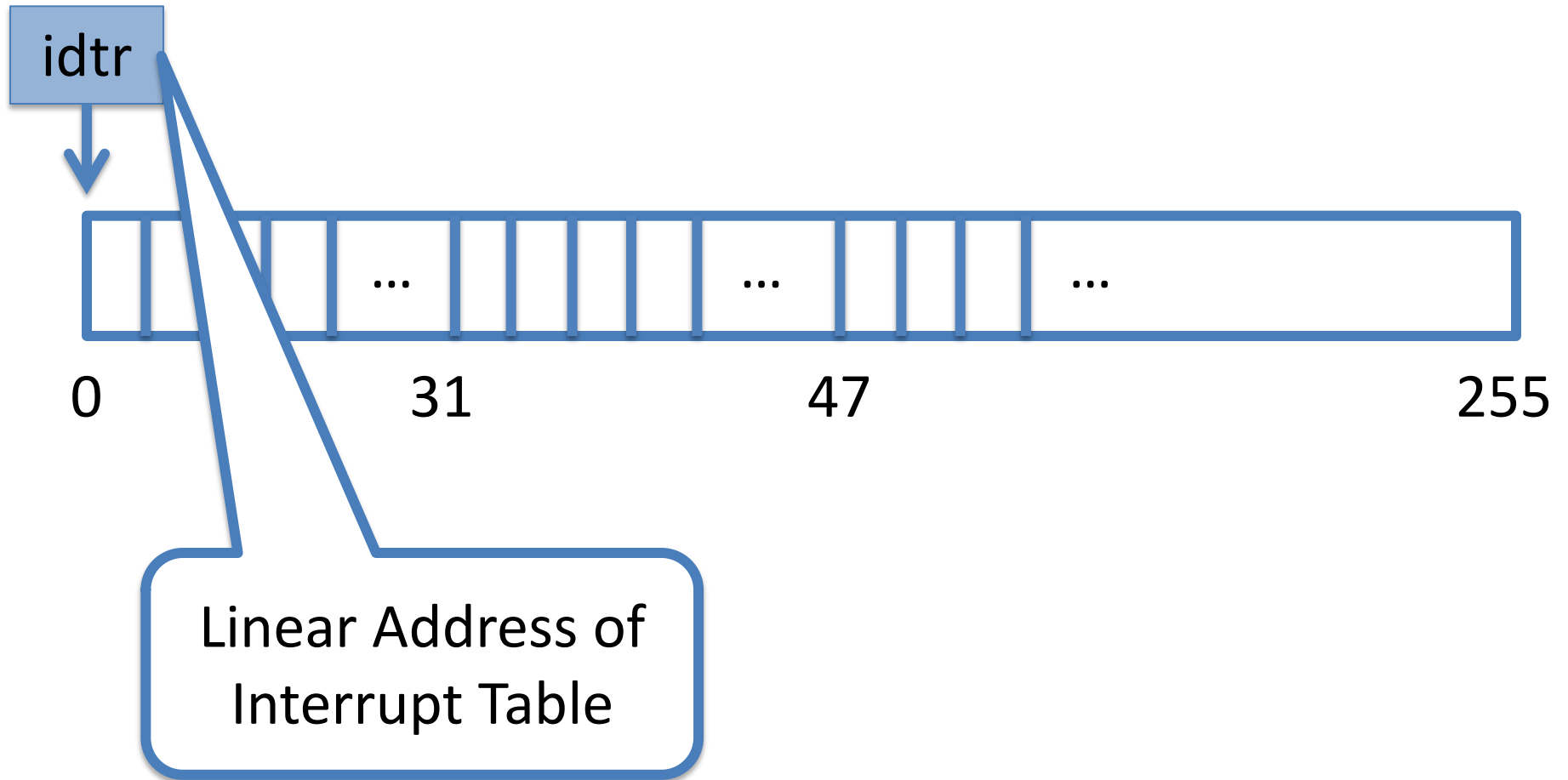



x86 interrupt table

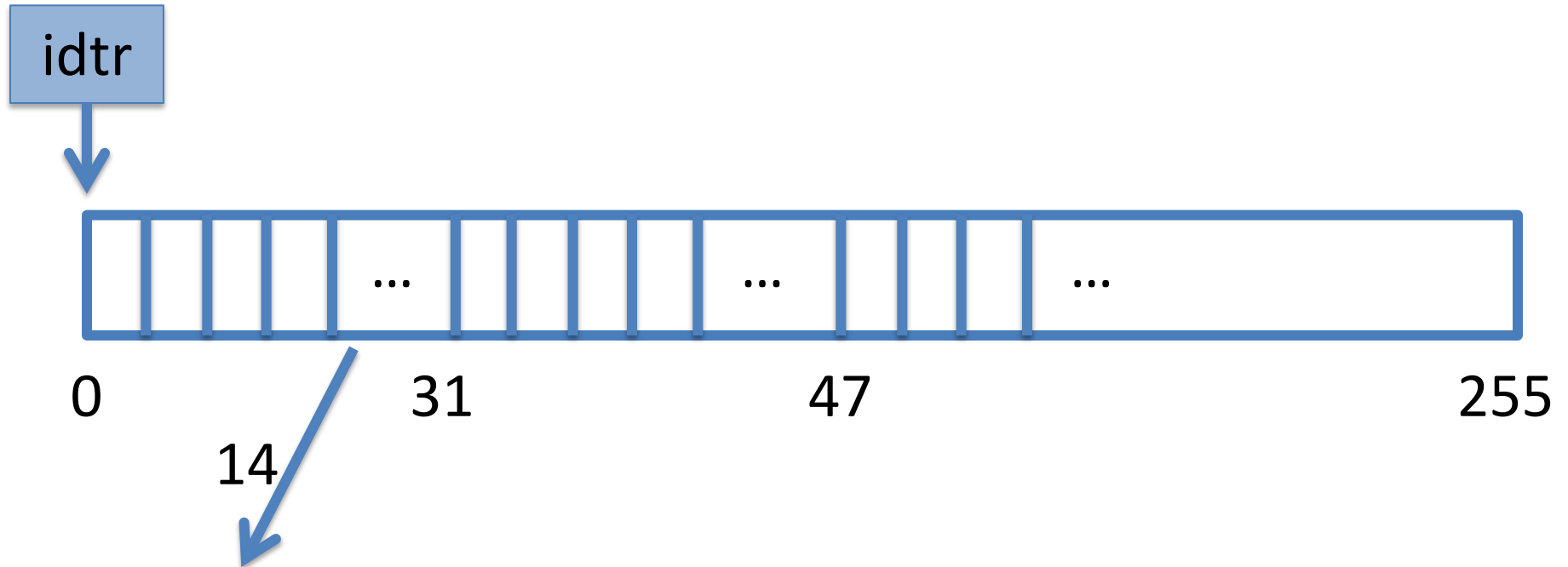

Code Segment: Kernel Code
Segment Offset: `&page_fault_handler` //linear addr
Ring: 0 // kernel
Present: 1
Gate Type: Exception



Interrupt Descriptor

- Code segment selector
 - Almost always the same (kernel code segment)
 - Recall, this was designed before paging on x86!
- Segment offset of the code to run
 - Kernel segment is “flat”, so this is just the linear address
- Privilege Level (ring)
 - Ring that can raise this interrupt with an `int` instruction
- Present bit – disable unused interrupts
- Gate type (interrupt or trap/exception) – more in a bit



x86 interrupt table

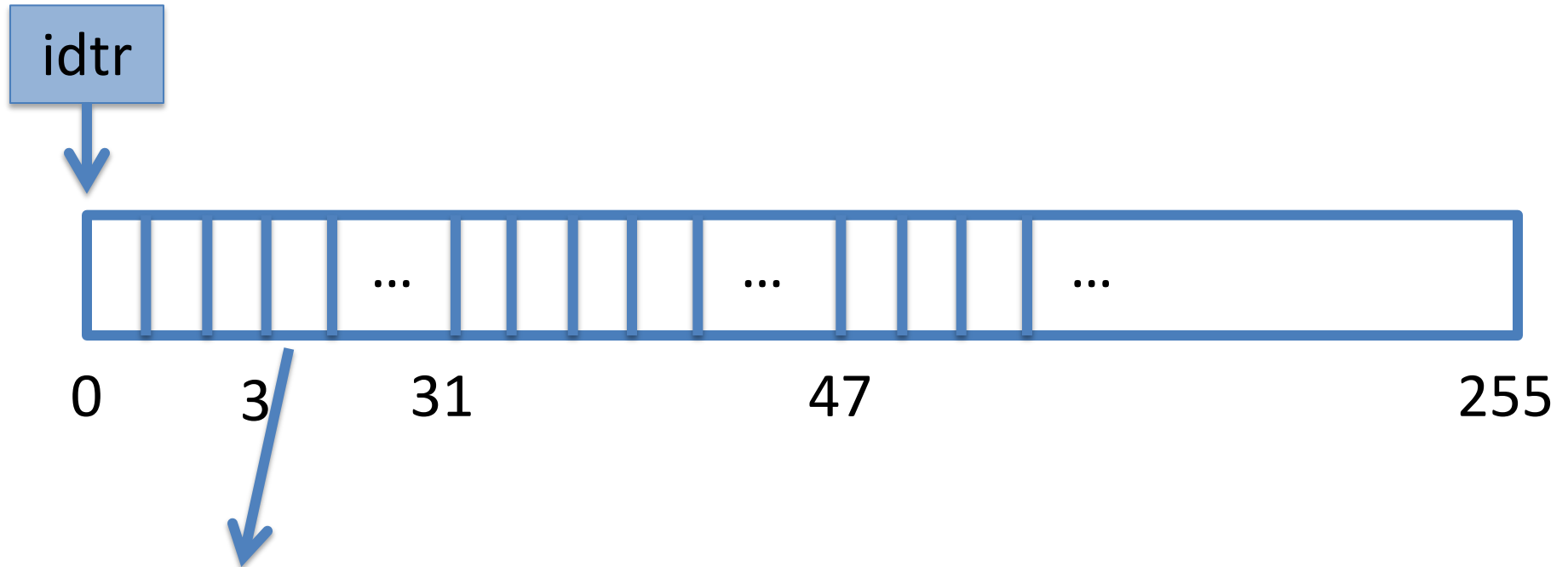

Code Segment: Kernel Code
Segment Offset: &breakpoint_handler //linear addr
Ring: 3 // user
Present: 1
Gate Type: Exception



Interrupt Descriptors, ctd.

- In-memory layout is a bit confusing
 - Like a lot of the x86 architecture, many interfaces were later deprecated
- Worth comparing Ch 9.5 of the i386 manual with `inc/mmu.h` in the JOS source code



How it works (HW)

- How does HW know what to execute?
 - Interrupt descriptor table specifies what code to run
 - And at what privilege (via code segment)
 - This can be set up once during boot for the whole system
- Where does the HW dump the registers; what does it use as the interrupt handler's stack?
 - Specified in the Task State Segment



Task State Segment (TSS)

- Another segment, just like the code and data segment
 - A descriptor created in the GDT (cannot be in LDT)
 - Selected by special task register (tr)
 - Unlike others, has a hardware-specified layout
- Lots of fields for rarely-used features
- Two features we care about in a modern OS:
 - 1) Location of kernel stack (fields `ss0/esp0`)
 - 2) I/O Port privileges (more in a later lecture)



TSS, cont.

- Simple model: specify a TSS for each process
 - Note: Only 2^{13} entries in the GDT
- Optimization (JOS):
 - Our kernel is pretty simple (uniprocessor only)
 - Why not just share one TSS and kernel stack per-process?
- Linux generalization:
 - One TSS per CPU
 - Modify TSS fields as part of context switching



Summary

- Most interrupt handling hardware state set during boot
- Each interrupt has an IDT entry specifying:
 - What code to execute, privilege level to raise the interrupt
- Stack to use specified in the TSS



Comment

- Again, segmentation rears its head
- You can't program OS-level code on x86 without getting your hands dirty with it
- Helps to know which features are important when reading the manuals



Lecture outline

- Overview
- How interrupts work in hardware
- **How interrupt handlers work in software**
- How system calls work
- New system call hardware on x86



High-level goal

- Respond to some event, return control to the appropriate process
- What to do on:
 - Network packet arrives
 - Disk read completion
 - Divide by zero
 - System call



Interrupt Handlers

- Just plain old kernel code



Example

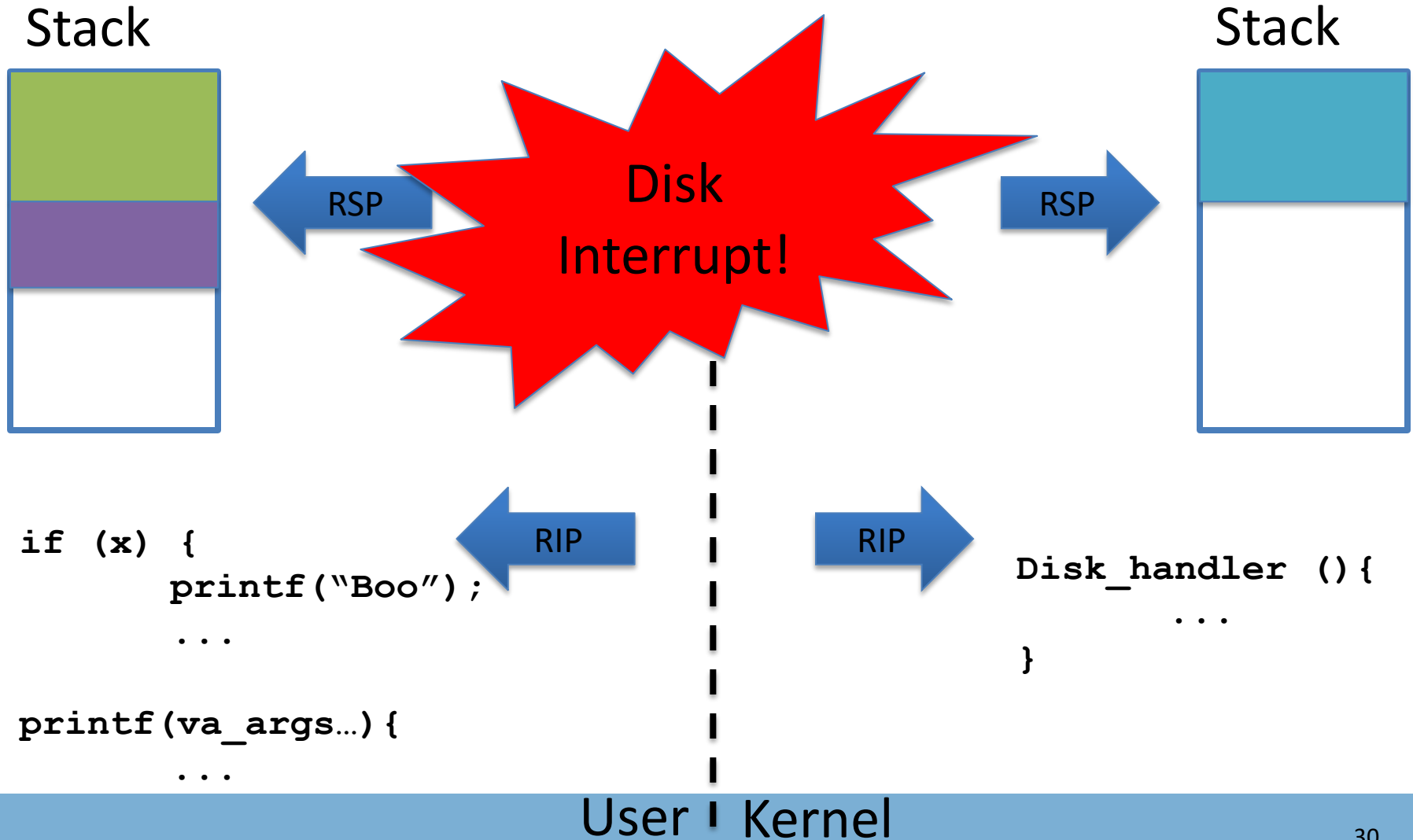



Complication:

- What happens if I'm in an interrupt handler, and another interrupt comes in?
 - Note: kernel stack only changes on privilege level change
 - Nested interrupts just push the next frame on the stack
- What could go wrong?
 - Violate code invariants
 - Deadlock
 - Exhaust the stack (if too many fire at once)



Example

Stack

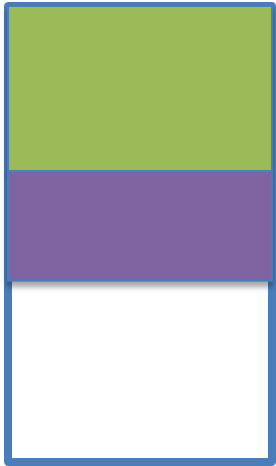

```
if (x) {
    printf("Boo'
    ...
printf(va_args...) {
    ...
```



Will Hang Forever!
Already Locked!!!



Stack

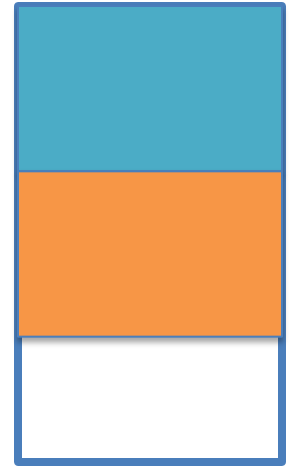

```
disk_handler () {
    lock_kernel ();
    ...
unlock_kernel ();
...
net_handler () {
    lock_kernel ();
    ...
```

User | Kernel



Bottom Line:

- Interrupt service routines must be reentrant or synchronize
- Period.



Hardware interrupt sync.

- While a CPU is servicing an interrupt on a given IRQ line, the same IRQ won't raise another interrupt until the routine completes
 - Bottom-line: device interrupt handler doesn't have to worry about being interrupted by itself
- *A different* device can interrupt the handler
 - Problematic if they share data structures
 - Like a list of free physical pages...
 - What if both try to grab a lock for the free list?



Disabling interrupts

- An x86 CPU can disable I/O interrupts
 - Clear bit 9 of the EFLAGS register (IF Flag)
 - `ccli` and `stii` instructions clear and set this flag
- Before touching a shared data structure (or grabbing a lock), an interrupt handler should disable I/O interrupts



Gate types

- Recall: an IDT entry can be an interrupt or an exception gate
- Difference?
 - An interrupt gate automatically disables all other interrupts (i.e., clears and sets IF on enter/exit)
 - An exception gate doesn't
- This is just a programmer convenience: you could do the same thing in software



Exceptions

- You can't mask exceptions
 - Why not?
 - Can't make progress after a divide-by-zero
 - Double and Triple faults detect faults in the kernel
- Do exception handlers need to be reentrant?
 - Not if your kernel has no bugs (or system calls in itself)
 - In certain cases, Linux allows nested page faults
 - E.g., to detect errors copying user-provided buffers



Summary

- Interrupt handlers need to synchronize, both with locks (multi-processor) and by disabling interrupts (same CPU)
- Exception handlers can't be masked
 - Nested exceptions generally avoided



Lecture outline

- Overview
- How interrupts work in hardware
- How interrupt handlers work in software
- **How system calls work**
- New system call hardware on x86



System call “interrupt”

- Originally, system calls issued using `int` instruction
- Dispatch routine was just an interrupt handler
- Like interrupts, system calls are arranged in a table
 - See `arch/x86/kernel/syscall_table*.S` in Linux source
- Program selects the one it wants by placing index in `eax` register
 - Arguments go in the other registers by calling convention
 - Return value goes in `eax`



Lecture outline

- Overview
- How interrupts work in hardware
- How interrupt handlers work in software
- How system calls work
- **New system call hardware on x86**



Around P4 era...

- Processors got very deeply pipelined
 - Pipeline stalls/flushes became very expensive
 - Cache misses can cause pipeline stalls
- System calls took twice as long from P3 to P4
 - Why?
 - IDT entry may not be in the cache
 - Different permissions constrain instruction reordering



Idea

- What if we cache the IDT entry for a system call in a special CPU register?
 - No more cache misses for the IDT!
 - Maybe we can also do more optimizations
- Assumption: system calls are frequent enough to be worth the transistor budget to implement this
 - What else could you do with extra transistors that helps performance?



AMD: syscall/sysret

- These instructions use MSR (machine specific registers) to store:
 - Syscall entry point and code segment
 - Kernel stack
- A drop-in replacement for `int 0x80`
- Everyone loved it and adopted it wholesale
 - Even Intel!



Aftermath

- Getpid() on my desktop machine (recent AMD 6-core):
 - Int 80: 371 cycles
 - Syscall: 231 cycles
- So system calls are definitely faster as a result!



In JOS

- You will use the `int` instruction to implement system calls
- There is a challenge problem in lab 3 (i.e., extra credit) to use `systementer/sysexit`
 - Note that there are some more details about register saving to deal with
 - `syscall/sysret` is a bit too trivial for extra credit
 - But still cool if you get it working!



Summary

- Interrupt handlers are specified in the IDT
- Understand when nested interrupts can happen
 - And how to prevent them when unsafe
- Understand optimized system call instructions
 - Be able to explain syscall vs. int 80